

0390203306

AHC2 Two-stage motor with Transmission

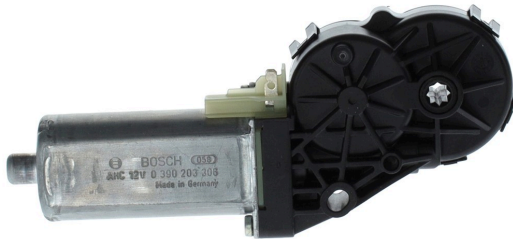

For reliable performance in reduced size: The Bosch compact geared motors are the appropriate solution for industrial applications with limited space. These drives exhibit high power density and cover a broad field of 12 and 24V requirements. Bosch offers different speed/torque characteristic curves and various mechanical interfaces.

- **Degree of protection:** IP 50
- **Operating mode:** S2
- **Rotation direction:** Left and right rotation
- **Nominal voltage:** 12 V



[Contact us!](#)

Product Specification

Technical data and performance curve

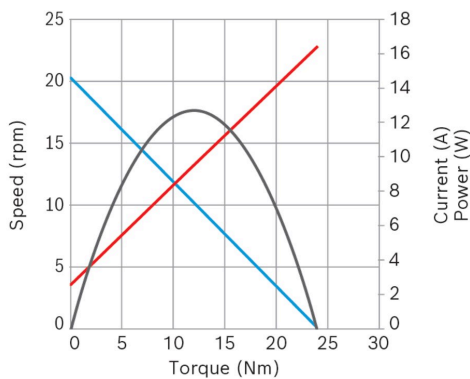

Nominal power (W): 3,9

Nominal current (A): 3,7

Nominal speed (rpm): 18,65

Nominal torque (Nm): 2

Stall torque (Nm): 23,9

Transmission ratio: 217:1

Hall Sensor: No

Transmission position: Right

Product images and pictures are for demonstration purposes only, the actual product may differ from the picture shown. The quotation drawing is binding.

Robert Bosch GmbH, Auf der Breit 4, 76227 Karlsruhe, Germany www.bosch-ibusiness.com



Dimensions

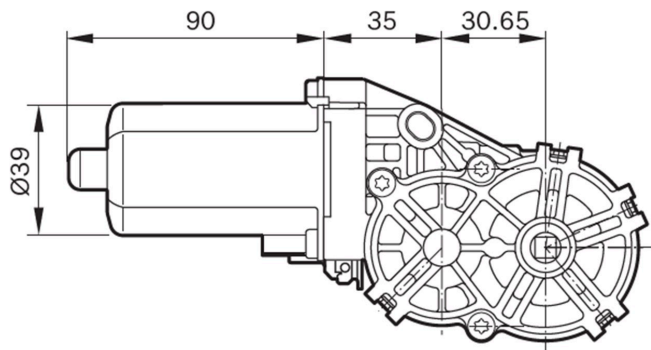

Please contact us if you need a 3d model

[Contact](#)

Circuit diagram

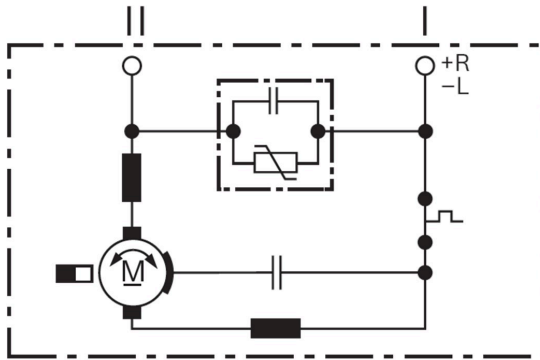

Connector

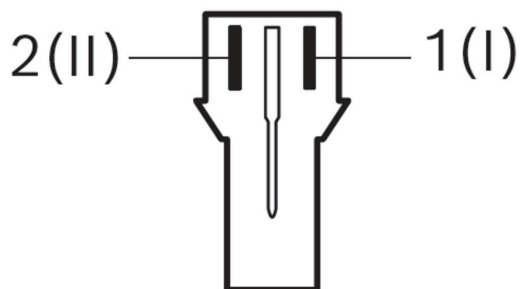

Housing:

TE 968182-1

Locker:

TE 968183-1

PIN:

TE JPT 0-927768-1



Drive interface

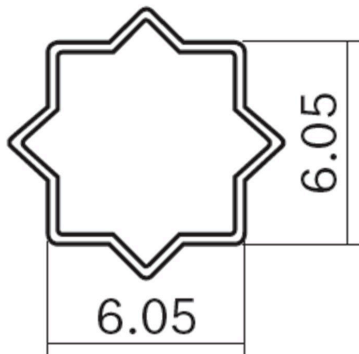

Features and benefits

- Rotation in both direction: The Bosch small geared motors can be used as a drive
- Available with hall sensor: For positioning or direction of rotation feedback
- Production in line with the original automotive quality guidelines: For proven quality, high reliability and a long service life
- Operating mode S2 or S3: Suitable for short-term or intermittent operation

Downloads

You may also be interested in:

To Product family: [Catalogue](#)

