

0986337409

EFP Large Electric Motor with Transmission



For reliable performance, robustness and broad variety of speed/torque: The Bosch large geared motors cover a wide range of 12V and 24V applications. Decades of experience in manufacturing of electric motors have led to the current design of the large geared motors CHP, CDP, EFP and WDD. Depending on the model, the rotating speed, rotating angle, position and the torque can be parameterized according to the design.

- **Degree of protection:** IP 23
- **Operating mode:** S1
- **Nominal voltage:** 24 V

[Contact us!](#)



Product Specification

Technical data and performance curve

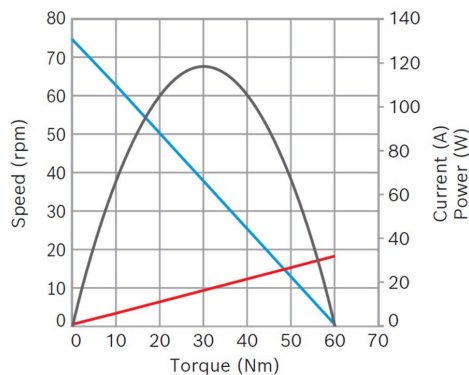

Nominal power (W): 65,9

Nominal current (A): 6

Nominal speed (rpm): 63

Nominal torque (Nm): 10

Stall torque (Nm): 60

Transmission ratio: 80:2

Rotation direction: Left and right rotation

Hall Sensor: No

Transmission position: Left

Product images and pictures are for demonstration purposes only, the actual product may differ from the picture shown. The quotation drawing is binding.

Robert Bosch GmbH, Auf der Breit 4, 76227 Karlsruhe, Germany www.bosch-ibusiness.com



Dimensions

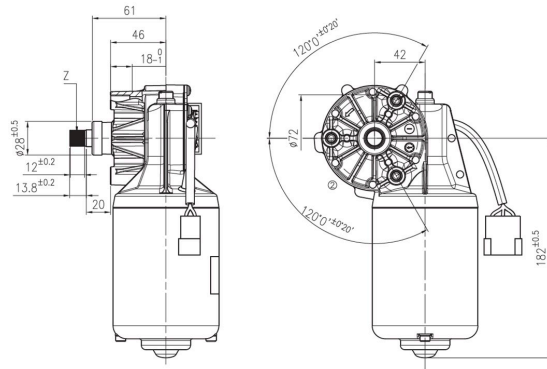

Please contact us if you need a 3d model

[Contact](#)

Circuit diagram

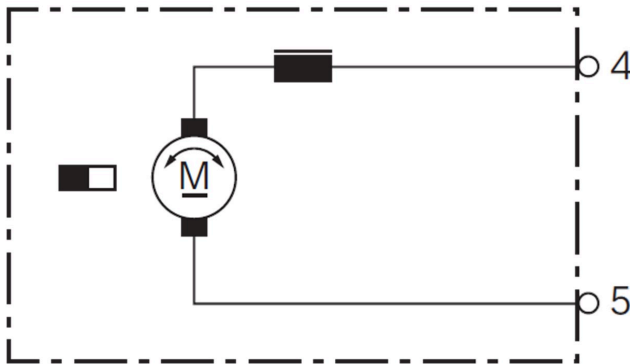

Connector

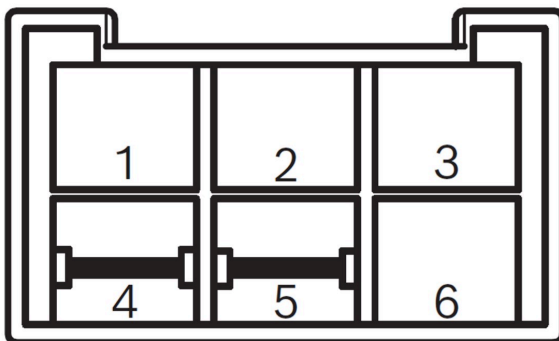

C-180906

- 1: not connected
- 2: not connected
- 3: not connected
- 4: First speed (Green)
- 5: Minus (Black)
- 6: not connected



Drive interface

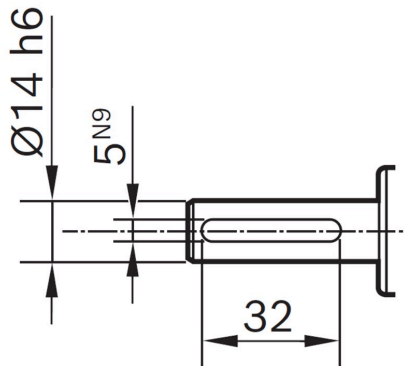

Features and benefits

- Models with integrated electronics: Suitable for a wide range of applications and depending on model equipped with bus communication digital/LIN/CAN as well as teach-in functions
- Rotation in both directions: For using the motor as a drive or as an actuator
- Production in line with the original automotive quality guidelines: For proven quality, high reliability and a long service life
- Operating mode S1: Suitable for continuous operation

Downloads

You may also be interested in:

To Product family: [Catalogue](#)

